

SIEMENS



RDS120

Smart Thermostat

User Guide

Table of Contents

1	About this User guide	5
1.1	Revision history	5
1.2	Reference documents.....	5
1.3	Before starting	5
2	Getting started with the thermostat	8
2.1	Thermostat display overview.....	8
2.2	Home screen icon overview	10
3	Presence detection	12
3.1	Presence detection using the built-in PIR sensor.....	12
3.2	Approach detection.....	13
4	Operating the thermostat from the thermostat main unit	15
4.1	Temperature control	15
4.2	Operating modes	16
4.2.1	Operating modes overview.....	16
4.2.2	Operating modes in a schedule.....	17
4.3	WLAN connection.....	17
4.4	Screen lock protection	19
4.4.1	Locking the home screen	19
4.4.2	Creating an administrator password	20
4.5	Fan control	21
4.6	Turning on/off the touch sound.....	21
4.7	Changing the display language	21
4.8	Naming a room	21
4.9	Changing a time zone	22
4.10	Checking the basic information about the thermostat	22
4.11	Software updates.....	22
5	Green leaf	23
6	Air quality control	24
7	Operating the thermostat from the mobile app	25
7.1	Downloading the app	25
7.2	Account creation and pairing.....	25
7.3	Changing background color	26
7.4	Managing information about the thermostat remotely	26
7.5	Widget overview	27
7.5.1	Temperature control widget overview	28
7.5.2	Fan widget overview	29
7.5.3	Running hours widget overview.....	30
7.6	Temperature control	31

7.7	Fan control	31
7.8	Switching between Away and At home.....	31
7.9	Setting schedules	31
7.10	Switching between Heating and Cooling	33
8	Appendices.....	34
8.1	Frequently asked questions	34
8.1.1	What should I do if I forget the screen lock code?.....	34
8.1.2	What if two users change the same setting at the same time?	34
8.1.3	Will the thermostat work if the connection to the cloud is lost?	34
8.1.4	Why does the scheduled Eco mode change to Comfort?	34
8.1.5	What is the difference between Administrated WLAN and Private WLAN?	35
8.1.6	What if the WLAN network is down during software updates?.....	35
8.1.7	Can I change the Green leaf settings?	35
8.1.8	Can I change the air quality measurement standard?	35
8.1.9	Where can I check the current time on the thermostat?	35
8.1.10	Can the thermostat display the time correctly if there is no WLAN connection?	36
8.1.11	Can I set the time manually?	36
8.1.12	Why is the time displayed incorrectly even though the thermostat is added to a WLAN network?	36
8.1.13	How does the built-in PIR sensor work?	36
8.1.14	What should I do if I forget my account's password?	36
8.1.15	I have registered an account but cannot log in.....	36
8.1.16	I have signed up but have not received a confirmation email.	36
8.1.17	Can I create more than one user account in the mobile app?	36
8.1.18	How long are date and time valid, if power fails and the thermostat has no connection to the cloud?	37
8.1.19	How long are settings saved in the thermostat if power fails?	37
8.1.20	How does Free cooling work?	37
8.2	Technical specifications	37
8.3	Regulatory information.....	37
8.3.1	ISED Regulations (Canada)	37
8.3.2	FCC Regulations (USA)	38
8.4	EULA.....	38

1 About this User guide

1.1 Revision history

Edition	Date	Changes	Section	Pages
3	July 2018	Third version. <ul style="list-style-type: none"> Added information on Fan min. ON time. Added information on time synchronization and setting valid period after power failure. Added information on Free cooling. 	4.5 8.1.18 8.1.19 8.1.20	21 39
2	April 2018	Second version. <ul style="list-style-type: none"> Added reference document Submittal Sheet. 	1.2	5
1	December. 2017	First version.	All	

1.2 Reference documents

Ref.	Document title	Document
[1]	Mounting instructions	Multi-lingual version
[2]	Quick guide	en
		es
		fr
[3]	Data sheet	en
		es
[4]	Commissioning	en
		es
[5]	Submittal sheet	en
		es

1.3 Before starting

Trademarks

The table below lists the third-party trademarks used in this document and their legal owners. The use of trademarks is subject to international and domestic provisions of the law.

Trademarks	Legal owner
App Store®	Apple Inc.
Google Play™	Google Inc.
Wi-Fi®	Wi-Fi Alliance

All product names listed in the table are registered (®) or not registered (™) trademarks of the owner listed in the table. We forgo the labeling (e.g. using the symbols ® and ™) of trademarks for the purposes of legibility based on the reference in this section.

Copyright

This document may be duplicated and distributed only with the express permission of Siemens.

Conventions for text marking

Notations

Special notations are shown in this document as follows:

▷	Specifies the requirements that must be met before performing this procedure.
1. 2.	Procedures must be performed in the specified order.
[→ X]	Reference to a page number
>	Relation sign and for identification between steps in a sequence, e.g., Menu bar >Help > Help topics.

Symbol identifications

	⚠ WARNING
	This is the symbol for hazard. It warns of Risks of personal injury . Comply with all measures designated by this symbol to prevent injury or death.

	NOTICE
	This symbol identifies an important notice.



The 'i' symbol identifies supplementary information and tips.

Before starting

It is important to read the documents supplied with or ordered at the same time as the products (equipment, applications, tools, and so on) carefully and in full.

Before getting started, ensure there is an internet connection, a valid email address and a smartphone readily available.

Siemens assumes no liability to the extent allowed under the law for any losses resulting from a failure to comply with the aforementioned points or for the improper compliance of the same.

2 Getting started with the thermostat

2.1 Thermostat display overview

Normal display

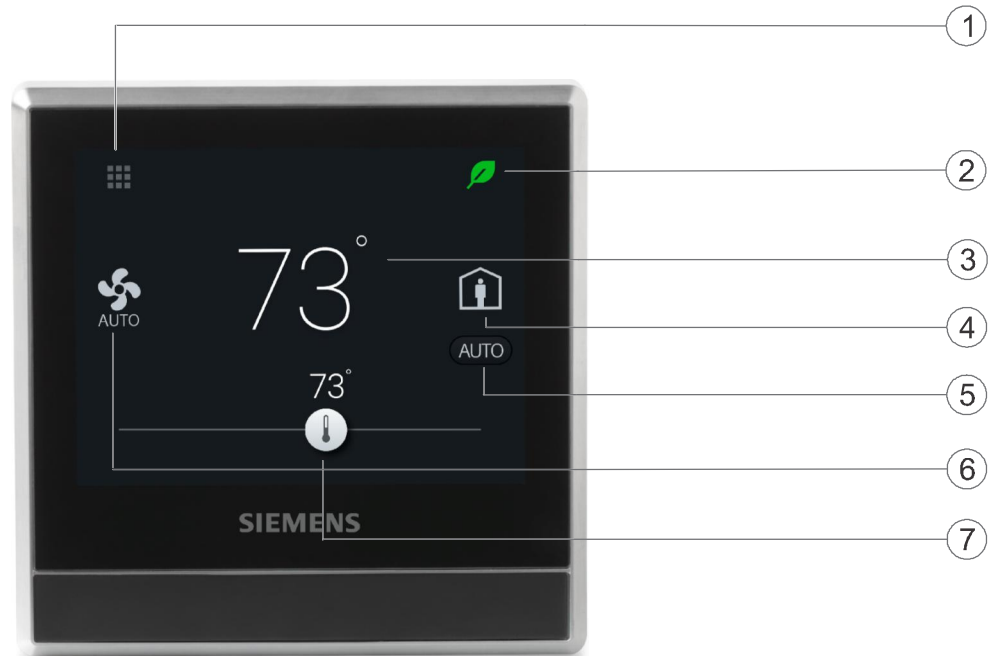

Icon	Description
1	Tap to display detailed information and additional settings.
2	Displays whether the system is in an energy-optimized mode. If the leaf is red, predefined settings were changed. Tap the red leaf to restore the energy-saving mode. The leaf turns green.
3	Room temperature.

Icon	Description
4	Tap to toggle between At home and AWAY .
5	Displays whether the thermostat is following a schedule (🕒) or following the setpoint changes permanently (🔴). Following a schedule can mean the following: <ul style="list-style-type: none"> • If there is network connection and the schedule has been set, the thermostat follows the schedule. The temporary change of the temperature setpoint is effective only during the currently scheduled mode. • If there is network connection but no schedule has been set, the thermostat follows the default schedule in the system. For more information about the default schedule, see Setting schedules [→ 31]. • If there is no network connection or valid time, the thermostat cannot retrieve schedule information from the Cloud. It will operate in the Comfort mode.
6	Tap to select a fan mode (AUTO/ON).
7	Tap or slide to change the room temperature setpoint.



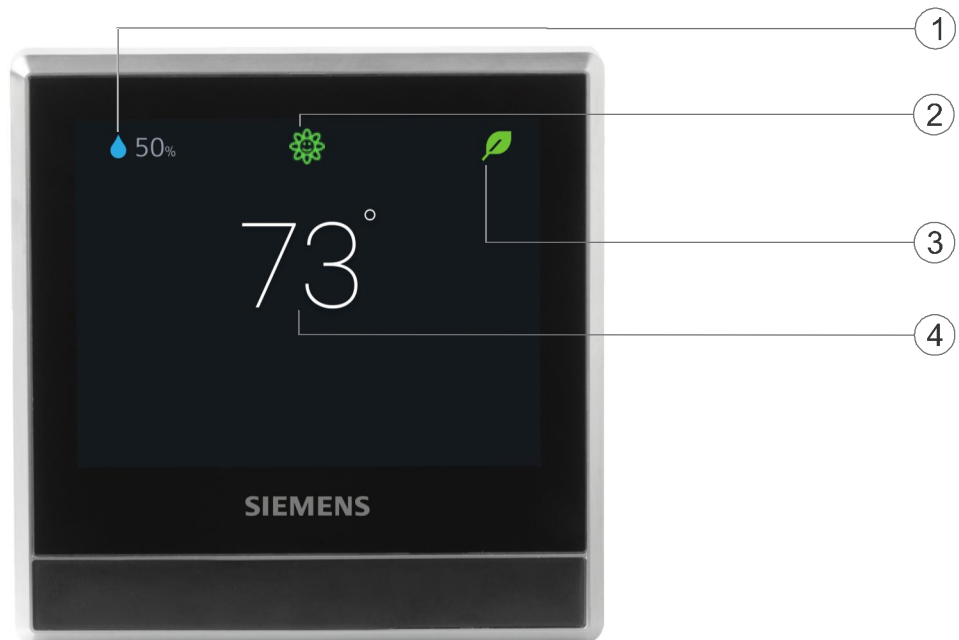



Idle display











Icon	Description
1	Measured relative humidity
2	Shows room air quality: <ul style="list-style-type: none"> • If the icon is green, the air quality is good. • If the icon is orange, the air quality is average. • If the icon is red, the air quality is poor. In order to ensure that the room air quality is measured accurately when the room is closed for a long time, it is recommended to force air circulation such as opening a window.
3	Displays whether the system is in an energy-optimized mode. If the leaf is red, predefined settings were changed. Tap the red leaf to restore the energy-saving mode. The leaf turns green.
4	Measured room temperature.

NOTE: The icons displayed under the idle mode may differ for different scenarios. For example, the outside air temperature icon  may also be displayed on the screen if you've connected an external outside air temperature sensor and configured it correctly.

2.2 Home screen icon overview

Icon	Description
	The device is connected to the cloud server but not associated with an account.
	The fan icon. Fan status could be ON or AUTO. It is indicated by the text under the icon.
	At home mode is on.
	AWAY mode is active.
	Displays when the system works in an energy-optimized mode. If the leaf is red, it means that some pre-defined settings have been changed. Tap the red leaf to restore to the energy-saving mode. The leaf turns green.
	Temperature setpoint slider. Icon color changes as setpoint is changed: <ul style="list-style-type: none"> • Slider changes to orange when setpoint is moved to a point that is higher than the current room temperature and the system enters heating mode to warm up the room. • Slider changes to blue when setpoint is moved to a point that is lower than the current room temperature and the system enters cooling mode to cool down the room. • If the system has reached setpoint and is idle, the slider color stays white. NOTE: The condition of switching between heating and cooling modes is that the thermostat has been configured accordingly and then the thermostat responds based on the background logical processing of the comparison between the current room temperature and the heating and cooling setpoint for the current mode.

Icon	Description
	Relative room humidity
	<p>The thermostat operates under a schedule. If a schedule has not been set, the thermostat operates with the default schedule. This default schedule may be the system default or may be specific under Advanced Settings > Optimization.</p> <p>When this icon is toggled on, the temporary change of the temperature setpoint and fan settings only takes effect during the current scheduled mode and will be overridden to the scheduled settings when the next scheduled mode starts.</p> <p>NOTE: If the thermostat has not been connected to a WLAN network, it cannot read the real time from the network and thus cannot follow a schedule. In this case, it always works under the Comfort mode.</p>
	User overridden. Temporary setpoint changes or fan settings are effective if this icon is toggled on.
	Tap to display options, such as Operation Mode , Settings and Advanced Settings .
	Indicates the room air quality is good.
	Indicates the room air quality is average.
	Indicates the room air quality is poor.
	Indicates the outside air temperature. The temperature value is displayed beside this icon. Note that this value is valid only if you've connected an external outside air temperature sensor, configured it correctly and the sensor itself can provide valid values.

3 Presence detection

3.1 Presence detection using the built-in PIR sensor

By using a built-in presence detection sensor (also called PIR (Passive infrared detector) sensor), the thermostat detects occupancy and then does the following:

- Activates idle display. When no operations are performed, the thermostat detects presence in room. Upon presence, it displays information such as room temperature, room air quality and relative room humidity. If unoccupied, it turns off the screen.
- Changes the operating mode from **Unoccupied** to **Comfort**. If presence is detected in a formerly unoccupied room during a scheduled **Unoccupied** period, the thermostat switches to **Comfort** automatically until the next scheduled mode starts. However, this function is disabled by default and must be enabled manually if so desired.

Sensor location

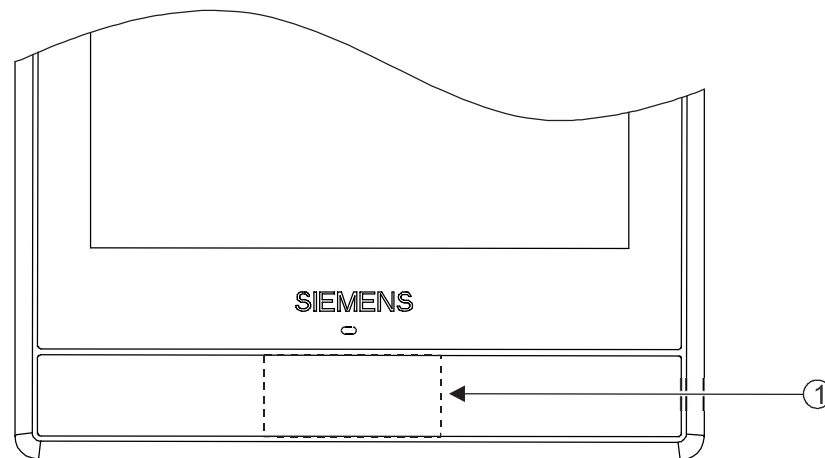





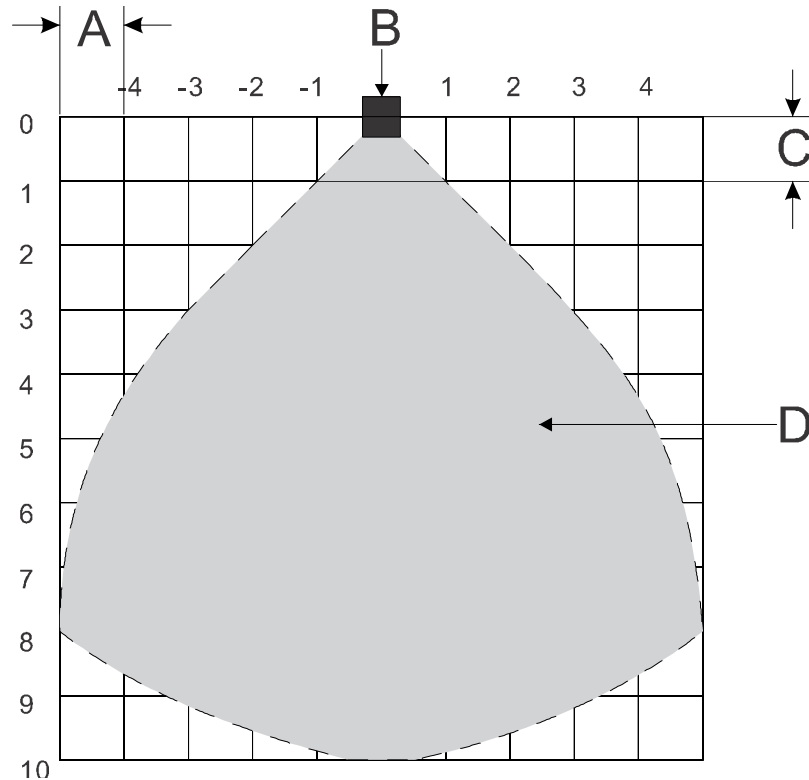

1	The location of the PIR sensor. It is a black area if seen from the front of the front module.
---	--

Sensor detection range



A	The width of each cell. It is 80 cm (31 in).
B	The thermostat.
C	The height of each cell. It is 80 cm (31 in).
D	The area that the PIR sensor can detect.

Change from Unoccupied to Comfort when an unoccupied room becomes occupied

1. On the Home screen, tap , tap  and then tap .
2. If prompted, enter the administrator password.
3. Tap , tap , and then tap . Scroll down and tap **Room presence detector**.
4. Drag the slider to the right.

3.2 Approach detection

The thermostat has a built-in approach sensor. It can detect someone approaching the thermostat. If activity is sensed within 10 cm, it will switch from its idle screen to the main home screen with full temperature and setpoint display.

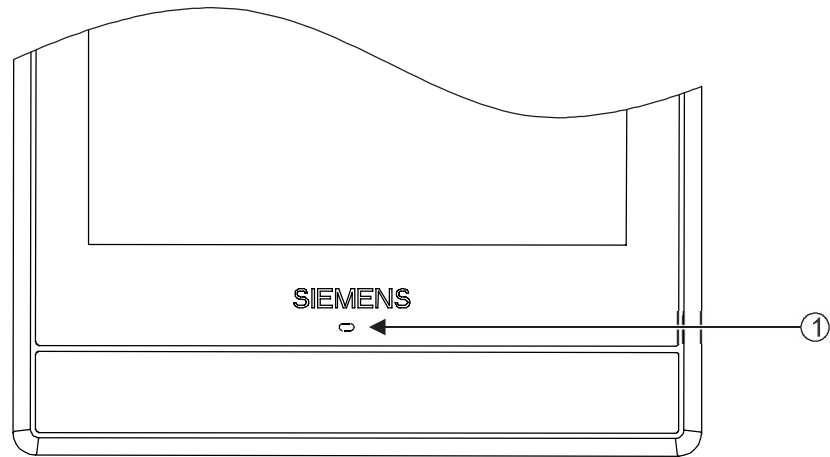
Sensor position

1	The location of the approach sensor.
---	--------------------------------------

4 Operating the thermostat from the thermostat main unit

4.1 Temperature control

The thermostat acquires the room temperature using the built-in sensor and/or the external room temperature sensor, and maintains the setpoint by delivering control commands to heating and/or cooling equipment. If no external room temperature sensor is connected or if the input value of the external sensor is invalid, only the built-in sensor is used to provide values for the thermostat. If the external sensor is connected and can provide valid values with the built-in sensor, the thermostat displays the average value of the built-in and external sensors.

On the home screen, the current room temperature is displayed and the temperature setpoint can be changed as desired. The units can be selected between °C and °F (the default unit).



NOTICE

After the initial setup of the thermostat, the displayed room temperature may not be correct because the temperature sensors need time for the calibration. Wait for at least one hour for the calibration.

To adjust the temperature setpoint on the home screen









- From the Home screen, drag the temperature slider to the right to increase the temperature setpoint, or to the left to decrease the temperature setpoint.

To change the temperature unit

1. From the Home screen, tap and then tap >.
2. Tap and then tap °F to change from Fahrenheit to Celsius, or tap °C to change from Celsius to Fahrenheit.

4.2 Operating modes

4.2.1 Operating modes overview

Operating mode	Description
At home	This mode lets the thermostat know the space is now occupied. Within this mode, you can choose  where the thermostat follows a schedule, or toggle to  and have the thermostat operate at a specified setpoint indefinitely. See Thermostat display overview [→ 8] for more detailed information about how the thermostat operates in  or  .
AWAY	This mode lets the thermostat know that space is no longer occupied and switches to the energy saving mode; the same as set up in Unoccupied mode using the mobile app.
AUTO	This commands the thermostat and the controlled HVAC system to switch between heating and cooling. This is the default setting. NOTE: it is different from  on the Home screen. For more information about the functions of  , see Operating modes in a schedule [→ 17].
HEAT 	Puts thermostat and the controlled HVAC system into Heating only operation.
COOL 	Puts the thermostat and the controlled HVAC system into Cooling only operation.
OFF	Depending on thermostat setup, this mode results in: <ul style="list-style-type: none"> Controlled HVAC system turns off completely. The thermostat is set to maintain the space within preset limits to avoid frost or heat damage or excessively low or high humidity. For more information about the protection setpoint, see Commissioning.





NOTE: If the heating or cooling stage is set to zero during the initial setup, **OFF** mode is the only available option from the **Operation Mode** page.

To switch to the OFF mode



- From the Home screen, tap , and then tap **OFF** on the Operation Mode page.

NOTE: To awake the thermostat from the **OFF** mode, tap the screen.



To change the thermostat behavior under the OFF mode

- From the Home screen, tap , tap < and then tap .
- If prompted, enter the administrator password.
- Tap , tap , and then tap **Off/protection configuration**.
- Tap either **OFF** or **Protection**.

To switch between At home and AWAY modes

- From the Home screen, tap  to switch from **At home** to **AWAY**.
- Tap  to switch from **AWAY** to **At home**.

To change the default AUTO mode

1. From the Home screen, tap .
2. On the Operation Mode page, tap either HEAT () , COOL () or OFF.

NOTE: To modify advanced settings on the heating or cooling mode, see [Commissioning](#).

4.2.2 Operating modes in a schedule

Operating mode overview

Operating mode	Description
Comfort	Maintains comfortable settings in controlled space during occupancy and activities.
Economy	Using set back (set up) settings, maintains balance in comfort during night time or inactivity and reduces energy consumption.
Unoccupied	Saves energy when space is unoccupied for extended periods.

These operating modes have different temperature, humidification, dehumidification and air quality setpoints. These setpoints can be changed by choosing **Advanced Settings > Optimization**. Unlike the humidification setpoint or dehumidification setpoint, the temperature setpoint can be adjusted directly from the thermostat home screen or using the mobile app.

Time scheduling of these operating modes (Comfort, Economy and Unoccupied) can only be done on the mobile app but the schedule can be initiated on the thermostat itself. If a set point is overridden during a time schedule period, that change will revert to the scheduled setting during the next transition. Override information is visible on both the thermostat screen and the mobile app.

NOTE: See Setting schedules [→ 31] for more details about scheduling.

To switch the thermostat to work following a schedule

- From the Home screen, tap  if  is not displayed on the screen.











NOTE: Unlike when a schedule is running, all the changes hold indefinitely if  is toggled on.

4.3 WLAN connection

Connecting to a WLAN network allows the thermostat to be connected to the cloud server and be controlled from a smartphone. Depending on how thermostat internet connection is set up, go to **Advanced Settings** or **Settings** to manage the WLAN connection:







- If **Private WLAN** (home use) is selected, go to **Settings**.
- If **Administrated WLAN *** (commercial use) is selected, go to **Advanced Settings**.

To connect to a network







1. If the thermostat is selected for commercial application (common wireless infrastructure), do the following:
 - From the Home screen, tap , and then tap . The **Advanced Settings** page displays.
 - If required, enter the administrator password.
 - Tap , and then tap . Wait for the thermostat to discover the networks nearby.
2. If the thermostat is selected for residential application (individual wireless infrastructure), do the following:
 - From the Home screen, tap , and then tap  until the **Settings** page displays.
 - Tap , and then tap . Wait for the thermostat to discover the networks nearby.
3. Tap the desired network. If necessary, tap  or  to scroll through the networks to select one.
4. For secured networks, enter the selected password, then tap **Connect**.

Note: For more information about the administrator password, see Creating an administrator password [→ 20].

To add a network manually

1. If the thermostat is selected for commercial application:
 - On the **Advanced Settings** page, tap , tap , and then tap  to scroll down to find and tap **Add Network**.
2. If the thermostat is selected for residential application:
 - On the **Settings** page, tap , tap , and then tap  to scroll down to find and tap **Add Network**.
3. Enter the Network name (SSID) information.
4. To select a security type, tap the **Security** field.
5. Tap **Connect**.
6. If prompted, enter the relevant password, and then tap **Connect**.

To configure current network settings



1. If the thermostat is selected for commercial application:
 - On the **Advanced Settings** page, tap  and then tap . The current network displays on the screen.
2. If the thermostat is selected for residential application:
 - On the **Settings** page, tap  and then tap . The current network displays on the screen.
3. Tap **Network Settings**. The default DHCP (Dynamic host configuration protocol) setting page displays on the screen.
 - If necessary, tap  or  to scroll through and view other network DHCP settings like **Preferred DNS**.

- To customize the current network settings, tap **Manual**, select a field, or tap ▼ or ▲ to scroll to the desired field, and then enter a new setting.

Connecting to a network by button

A WPS (Wi-Fi Protected Setup) compatible router allows push button wireless network set up. Please consult its manual for location of the WPS button.

To connect to a network by push button



1. If the thermostat is selected for commercial application:
 - On the **Advanced Settings** page, tap ⚙, tap , and then tap ▼ until **Push Button Setup** appears.
2. If the thermostat is selected for residential application:
 - On the **Settings** page, tap ⚙, tap , and then tap ▼ until **Push Button Setup** appears.
3. Tap **Push Button Setup**, and then press the WPS button on the WPS-supported router to start the discovery of the thermostat.
4. On the thermostat, tap  and then tap **Connect**.
5. Tap **OK** once the thermostat is connected to the network successfully.

4.4 Screen lock protection

4.4.1 Locking the home screen

A numeric screen code can be set to lock the home screen to protect it from tampering. Apart from using the screen code to unlock the screen, the administrator password (if set) can be used to unlock the screen.

To create a screen lock code



1. From the Home screen, tap , then tap >.
2. Tap ⚙, tap  and then tap **Activate**. Enter a code consisting of six numbers, and then tap **OK**.
3. Tap **OK** again to confirm.

To unlock the home screen



- On the Home screen, enter the screen lock code directly and then tap **OK**.
- If an administration password has been set, tap the question mark on the screen, and then tap **Log in as administrator**.

NOTE: There is no limit of number of attempts to enter the numeric code. In case the screen lock is lost, the administrator password (if set) can be used to unlock the screen. For more information, see What should I do if I forget the screen lock code? [→ 34]

To modify a screen lock password

1. On the **Settings** page, tap .
2. Tap  and then tap **Change**. Specify a new numeric lock of six numbers, and then tap **OK**.
3. Tap **OK** to confirm.

To remove a screen lock password

1. On the **Settings** page, tap .
2. Tap , tap **Deactivate**, and then tap **OK** to confirm.

4.4.2 Creating an administrator password



NOTICE

If an administrator password is lost, there is no way to recover it.

If the thermostat is selected for commercial application, setting an administrator password can help prevent unauthorized access to **Advanced Settings** if it is installed in a public place. The password can be set in the setup wizard when the thermostat is powered the first time. It can be modified, deleted or set again under **Advanced Settings**.





Actions protected by the administrator password are listed below as well as under **Advanced Settings**.

- Checking the basic information about the thermostat.
- Viewing/Using the activation code of the thermostat.
- Changing or deactivating the administrator password.
- Setting up WLAN connection.
- Changing date and time.
- Changing application settings.
- Changing basic/extended configurations and doing factory resets.



If the thermostat is selected for residential application, options related to WLAN connection is accessible from **Settings** instead of **Advanced Settings**.

To create/activate administrator password under Advanced Settings

1. From the Home screen, tap , and then tap . The **Advanced Settings** page displays.
2. Tap , tap **Password** and then **Activate**.
3. View the password policy on the screen, and then tap .
4. Enter a strong password required by the password policy displayed on the screen, and then tap **OK**.
5. Tap **OK**.

To manage the administrator password

1. On the **Advanced Settings** page, tap  and then tap **Password**.
2. Modify or deactivate the administrator password.

4.5 Fan control

The fan operates as part of the AUTO mode or the ON mode.

Under the AUTO mode, the fan runs in any of the following situations:

- Heating is active.
- Cooling is active.
- The humidification function is active.
- The dehumidification function is active.
- Free-cooling is enabled.
- Ventilation is activated to improve the room air quality.

When the fan is switched off and ventilation is in AUTO mode, you can switch the fan from AUTO to ON as needed. The fan is switched on by default after three minutes.

User can adjust **Fan min. ON time** via **Advanced Settings > Optimization** to influence the fan's minimum runtime.





Under the ON mode, the fan works regardless of whether any of the above functions is on.

To switch the fan between the AUTO and ON modes

- From the Home screen, tap .



4.6 Turning on/off the touch sound

To turn on/off the touch sound

1. From the Home screen, tap , then tap  until the **Settings** page displays.
2. Tap , and then tap  or  to turn on or off the touch sound.

4.7 Changing the display language



To change the display language

1. On the **Settings** page, tap  and then tap .
2. Tap the desired language. If necessary, tap  to scroll to the desired selection.

4.8 Naming a room

A unique name can be assigned to each room that the thermostat is installed. Doing so helps identification of the room when remotely controlling the thermostat.









To name a room

1. On the **Settings** page, tap  and then tap .
2. Tap the text field, and then enter a room name as desired, or tap  to select a name from the pre-set list.
3. Tap **OK** once the room name is entered.

4.9 Changing a time zone

When there is internet connection, the thermostat automatically detects the time zone. However, it also can be changed manually.

To change the time zone





1. From the Home screen, tap , then tap  and .
2. If prompted, enter the administrator password.
3. Tap , tap , tap **Adapt**, and then select an area on the map.
4. Tap  or  to scroll to a desired time zone, tap to select it and then tap .
5. If it is connecting to the cloud, the thermostat detects the date and time automatically based on the previously-selected time zone. If it is not connecting to the cloud, follow the on-screen instructions to set the year, month and date manually.

4.10 Checking the basic information about the thermostat

To check the following information about the thermostat:

- Model name
- Activation code and serial number of the thermostat
- Software and hardware version
- MAC and IP address
- HVAC application

To check the basic information about the thermostat

1. From the Home screen, tap , tap  and then tap .
2. If prompted, enter the administrator password.
3. Tap  and then tap . Detailed information about the thermostat displays.

4.11 Software updates

The thermostat receives updates to get the latest functionality, enhancements and bug fixes to ensure optimal performance. Normally, updates occur automatically through WLAN connection. It works in the background and has no effect on the thermostat operations.

NOTE: During software updates, the system reboot(s) occurs automatically. All settings will be saved.

5 Green leaf

The Green leaf indicates that the system has an energy-optimized operation:

- Use Green Leaf default setpoints for heating and cooling.
- Run system automatically based on a schedule.
- Operate fan in **AUTO** mode if the thermostat controls external fan equipment.
- Switch to follow a schedule with presets defined under **Advanced Settings > Optimization**.



If the thermostat detects one of the following, the leaf icon turns to red. Touch the red leaf to switch the setting back to an energy-optimized operation.

- The room air temperature is 4 °F or 2 K higher than the default heating setpoint for **Comfort** or **Economy** when the heating output is energized.
- The room air temperature is 4 °F or 2 K lower than the default cooling setpoint for **Comfort** or **Economy** when the cooling output is energized.
- The fan operates in **ON** mode.

6 Air quality control

With its built-in and/or external VOC (Volatile Organic Compounds) sensor, the thermostat measures the room air quality and shows the air quality status symbol on the local idle screen. In the mobile app, the status is indicated by text.

If no external VOC sensor is connected or if the input value of the external sensor is invalid, only the built-in sensor is used to provide values for the thermostat. If the external sensor is connected and can provide valid values with the built-in sensor, the thermostat displays the higher value of the built-in and external sensors.

Symbol on the local idle screen	Text in the mobile app	Description	VOC level [% of the output range]
	Good	The room air quality is good	<50%
	Okay	The room air quality is average	50% ~ 80%
	Poor	The room air quality is poor	>80%

There is a default air quality setpoint for each operating mode in a schedule. It is adjustable under **Advanced Settings > Optimization**. If the actual VOC level is 10% higher than the default setpoint for the current operating mode, the ventilation function is activated to force air circulation.



To ensure that the room air quality is measured accurately when the room is closed for a long time, it is recommended to circulate air such as opening a window.

7 Operating the thermostat from the mobile app

7.1 Downloading the app

To control the thermostat remotely, download the **Siemens Smart Thermostat RDS** app from Google Play or App Store.

To download the app

1. Open Google Play or App Store, and then search for **Siemens Smart Thermostat RDS**.
2. In the searched result page, tap the item to view its details, then follow the instructions to complete the installation.







7.2 Account creation and pairing

Once the app has been downloaded, create an account and then associate the account with the thermostat(s). The following functions are available:

- Remote control – Control the thermostat remotely. Other users can also use the created account to control the thermostat(s).
- Account administration – Manage the user account remotely such as changing/resetting password and adding/removing devices.

To create an account in the app and associate it with the thermostat(s)

▷ The thermostat is connected to a network.

1. Open the app in the smartphone.
2. Enter a valid email address.
3. On the local thermostat, do one of the following:
 - From the Home screen of the thermostat, tap , tap , tap  and then tap .
 - If  is available on the Home screen, tap it and then tap . The activation code and the QR code will display.
4. In the app, scan the QR code using the built-in scanner or enter the activation code manually.
5. Agree to the terms of use, and then tap **Create**. A confirmation email will be sent.
6. Enter the code enclosed in the confirmation email, set a password for the account, then tap **Activate**.
7. To associate additional thermostats with the account, tap , tap **Devices**, tap **Add Device** and then add devices by scanning the corresponding QR codes.



After initial power-up of the thermostat and after initial system configuration, tap  to create an account and associate mobile app. Refer to the [quick guide](#) for more detailed information.



After reconfiguration of the thermostat, log out and return to the app before changes take effect.

To manage the account information in the app

1. In the app, tap ☰ and then tap **Account**.
2. Manage account information. For example, changing user name, modifying the password, or choosing another display language.

7.3 Changing background color

You can change the mobile app's background color from dark to light or vice versa as you like.

Change the theme color

1. In the app, tap ☰ > **Account**.
2. Expand the **Theme** field, and select any background color.

7.4 Managing information about the thermostat remotely

Once a thermostat is added to the mobile app, it is possible to view detailed information such as current connection status (e.g. online, offline or upgrading), to modify a room name and to remove a device.

The device's connection status

Online	The thermostat is connected to the cloud server.
Offline	<p>The thermostat is not connected to the cloud server. This will happen when the thermostat is powered off, is not connected to the internet or the smart phone is not connected to the internet.</p> <p>When a device is offline, only the following operations can be performed:</p> <ul style="list-style-type: none"> • Sign up, sign in or sign out. • Change or recover a password. • Change user account settings. • Delete device.
Upgrading	The thermostat is in the process of upgrading to a new software version. No operations can be performed when a device is upgrading.

Managing thermostat details

To change a room name

1. Tap ☰ and then tap **Devices**.
2. Select the desired device.
3. Tap the **Room** field. Enter the new room name.

To delete a thermostat

1. Tap  and then tap **Devices**.
2. Select the thermostat to be deleted.
3. Tap **Remove Device** and then tap **Yes**.

7.5 Widget overview

The main control screens of the thermostat consist of three widgets: the temperature control widget, the fan widget and the running hours widget. Swipe to the left or right to switch between widgets.



NOTE: The running hours widget indicates the heating and/or cooling consumption during a specific period of time. It displays only if you've enabled the heating and/or cooling.

To access the widgets

1. Open the app, and then select a specific location if more than one is listed. An overview of the current status in that location displays. If the account is associated with only one thermostat, the app automatically opens the temperature control widget.
2. If necessary, swipe to the right or left to view both widgets.

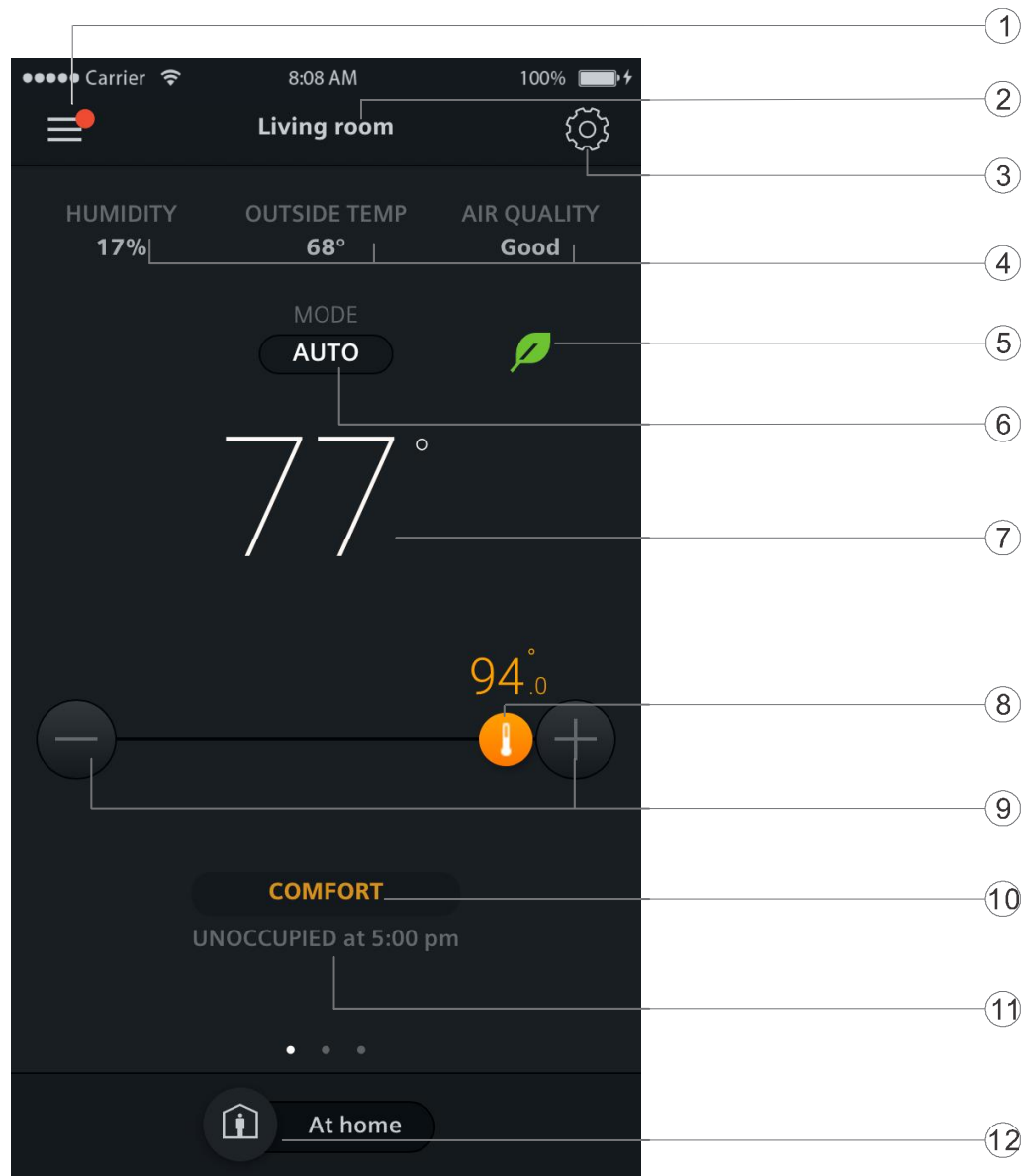
7.5.1 Temperature control widget overview



1	Options menu
2	Room name
3	Advanced settings.
4	Room humidity, outside air temperature and air quality display.
5	Indicates if the system is running in an energy-saving mode. If not, the leaf icon turns red. Touch the red leaf to switch back to energy-optimized operation.
6	Displays whether the thermostat is operating following a schedule or not.  indicates the schedule is running while  indicates the schedule is not activated. Tap the icon to toggle between the two modes. These two modes are also available on the Home screen of the local thermostat.
7	Displays the current room temperature.

8	Temperature setpoint slider. Drag the setpoint circle to the right to increase the setpoint and to the left to decrease the setpoint. The value in the circle changes accordingly.
9	Tap to decrease or increase the temperature setpoint.
10	Displays the current scheduled operating mode. Display is active only when the icon  is on the same screen. If the setpoint has been overridden, the temporary setpoint displays in this area.
11	Displays the next scheduled operating mode and when it starts.
12	Toggle to switch between At home and AWAY . These two modes are also available on the Home screen of the local thermostat. For more information about the two modes, see Operating modes overview [→ 16].

7.5.2 Fan widget overview

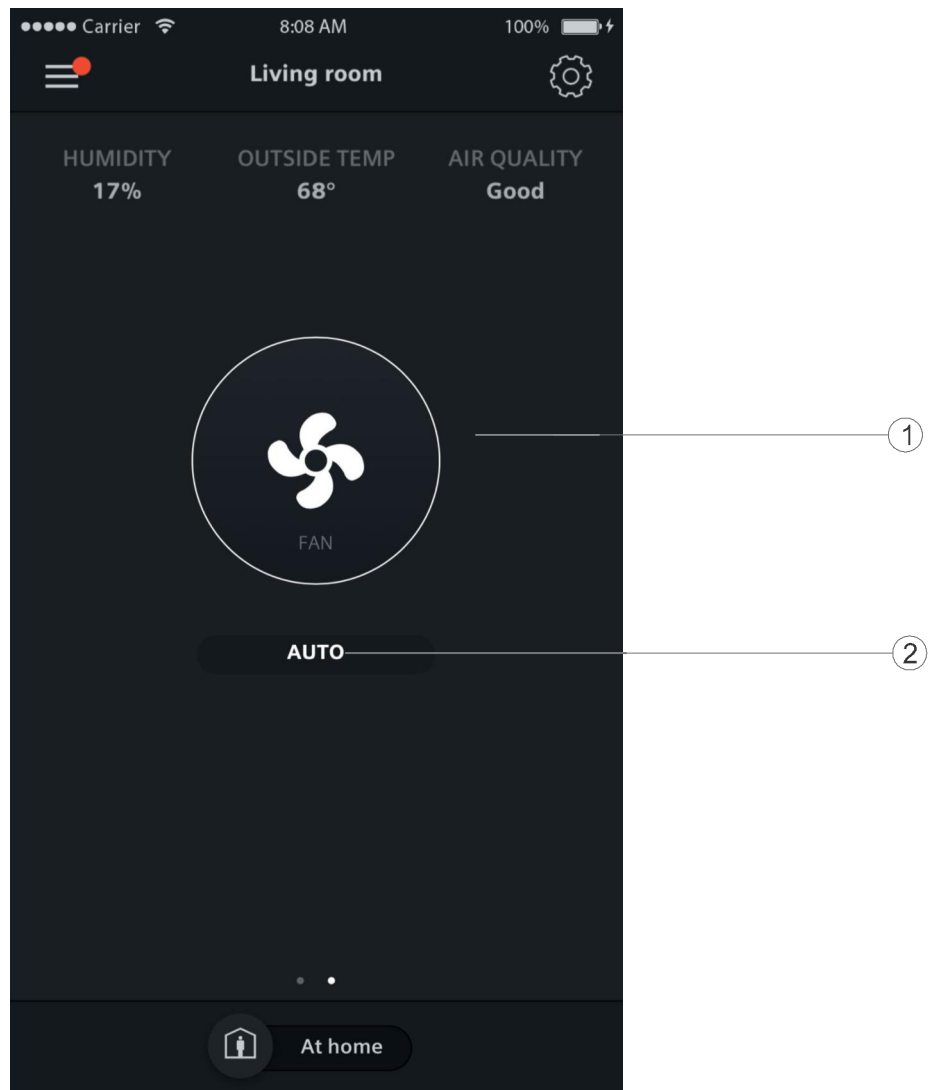

1	Toggle to switch between the automatic mode or ON mode. For more information about how the fan works, see Fan control [→ 21].
2	Display only. Indicates whether the fan is the automatic mode or ON mode.

7.5.3 Running hours widget overview

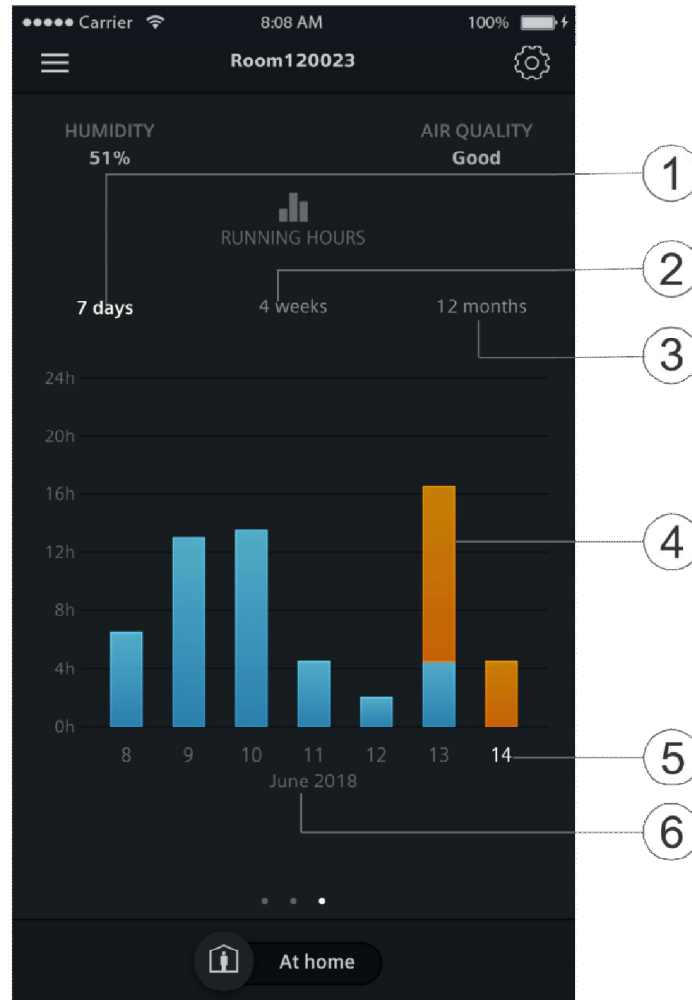

1	Seven-day view by default, showing the heating and/or cooling running hours of each week day counting down from the current day.
2	Tap to switch to the four-week view.
3	Tap to switch to the 12-month view.
4	Indication of heating and/or cooling running hours: Orange bars are for heating while blue bars for cooling.
5	The current day/month
6	The current month/year

7.6 Temperature control

Regardless of whether the thermostat is operating per a schedule, the temperature setpoint can be overridden. If a schedule is active, the change is effective within the current scheduled mode and the setpoint returns to a scheduled value when the next transition occurs. If no schedule is active, the change is indefinite unless another change is made. However, you can also change the default heating or cooling setpoints.

The temperature value can be in °C or °F. You can change the temperature unit under Account.

NOTE: For more information about schedules, see Setting schedules [→ 31].

To adjust the temperature setpoint

Do one of the following. Note that the first two options are to adjust the temperature setpoint temporarily within the current scheduled mode, while the last option is to adjust the default setpoints.

- On the temperature control widget, drag the temperature knob over the temperature line as desired.
- Tap the minus or plus icon on the widget.
- Tap , select an operation mode, and then either drag the slider or tap the minus or plus icon to change the default heating or cooling setpoint.

To change the temperature unit

1. In the app, tap  and then tap **Account**.
2. Expand the Unit field, and then change the temperature unit.

7.7 Fan control

For detailed information about fan control, see Fan control.

To switch the fan between the automatic and ON modes

- On the fan widget, tap **AUTO** or **ON**.

7.8 Switching between Away and At home

Set the thermostat to **At home** for comfort and Set it to **AWAY** to save energy.

To switch between AWAY and At home

- Tap **At home** or **AWAY** at the bottom of any widget.

7.9 Setting schedules



This is the default schedule:

Days	Time periods when Comfort mode is on	Time periods when Unoccupied mode is on
Monday to Friday	6 AM – 8 AM 5 PM – 10 PM	8 AM – 5 PM 10 PM – 6 AM
Saturday to Sunday	7 AM – 10 PM	10 PM – 7 AM

To program a different schedule, set up different time periods for the following operating modes: **Comfort**, **Economy** and **Unoccupied**. For more information about these operating modes, see Operating modes in a schedule [→ 17].

Once the schedule for one day is set, it can be copied to other days. In addition, preset setpoints for the different modes can be customized.

To initiate schedule operation

- From the Home screen of either the thermostat or the mobile app, tap  if  is not displayed on the screen.

To set time periods for different operating modes

1. On the temperature control widget screen, tap  and then tap **Thermostat schedule**.
2. Select which day of the week to set schedules for. By default, the system uses the current day.
3. On the vertical time line, tap and hold a specific time point to set a switching point. A switching point marker displays beside the time point. To fine tune the switching point, drag the switching point marker to the desired time.
4. Tap the switching point marker, and then select **Comfort**, **Economy** or **Unoccupied** from the drop-down list.
5. Repeat Steps 3 and 4 to set other switching points.

NOTE: A maximum of five switching points per day can be set. To delete one, tap  on the switching point marker.

To copy schedule from one day to others

1. On the temperature control widget screen, tap .
2. Tap **Thermostat schedule**.
3. Specify the day schedule to copy from.
4. Tap **Copy**, and then select which days to copy to.
5. Tap **Paste**. The schedule is pasted.

To change the preset setpoints for different operating modes

1. On the temperature control widget screen, tap .
2. Tap any of the modes, for example, **Unoccupied**, to expand the preset setpoints.
3. Drag the temperature slider to the setpoint.

7.10 Switching between Heating and Cooling

In the app, the default **AUTO** mode can be changed to **HEAT** or **COOL**, or **OFF** completely. For more information about the switchover between heating and cooling, see Operating modes overview [→ 16].

To change the default **AUTO** mode

1. On any of the widget screen, tap , and then expand the drop down list beside **Thermostat mode**.
2. Select either **HEAT**, **COOL** or **OFF**.

8 Appendices

8.1 Frequently asked questions

8.1.1 What should I do if I forget the screen lock code?

Try using the administrator password to unlock the screen.

To unlock the screen using the administrator password

1. On the thermostat screen indicating that the screen lock code is incorrect, tap the question mark and then tap **Login**.
2. Input the administrator password, and then tap **OK**.

8.1.2 What if two users change the same setting at the same time?

The last command received by the server takes effect.

8.1.3 Will the thermostat work if the connection to the cloud is lost?





Yes, the thermostat works with or without the network connection:

- If there is network connection to the cloud and you have also set the schedule, the thermostat operates per the schedule. The temporary change of the temperature setpoint is effective only during the current scheduled mode.
- If there is network connection but you have not set the schedule, the thermostat operates per the system default schedule. For more information about the default schedule, see Setting schedules [→ 31].
- If there is no network connection or valid time, the thermostat cannot get schedule information from the cloud. It always then operates in **Comfort** mode.

8.1.4 Why does the scheduled Eco mode change to Comfort?

This is probably because the thermostat detects that someone enters into the room when a scheduled **Unoccupied** mode is running. In this case, the thermostat switches from **Unoccupied** to **Comfort** automatically until the next scheduled mode starts. However, you can turn off the auto-switch by disabling the **Room presence detector** parameter under **Advanced Settings**.

Disable the switch from Unoccupied to Comfort even if the room is occupied

1. On the Home screen, tap , tap < and then tap .
2. If prompted, enter the administrator password.
3. Tap , tap , and then tap . Scroll down and tap **Room presence detector**.
4. Drag the slider to the left.

8.1.5 What is the difference between Administrated WLAN and Private WLAN?

Administrated WLAN * is supposed to connect to an infrastructure network managed by facility managers; **Private WLAN** fits for owner cases and is supposed to connect to a home network. Selecting the WLAN connection type differently only affects the entry to WLAN management:

- If you've selected **Administrated WLAN ***, you can only manage WLAN under **Advanced Settings**.
- If you've selected **Private WLAN**, you can manage WLAN under either **Settings** or **Advanced Settings**.

NOTE: In order to differentiate institutional use from home use, this document recommends only **Settings** for home users to manage the WLAN connection.

8.1.6 What if the WLAN network is down during software updates?

Reconnecting to the network resumes the updating process. However, if the network can't be reconnected within a short time and you want the thermostat to work normally during the disconnection period, tap and hold down the warning icon  displayed on the screen for at least ten seconds. You are then directed to the **Setup** page where you can check the previous settings, perform factory resetting or do nothing but return to the normal home screen.

8.1.7 Can I change the Green leaf settings?

No, you can't. The Green leaf settings are defined by the system and are not changeable from user side.

For more information about Green leaf, see Green leaf [→ 23].

8.1.8 Can I change the air quality measurement standard?

No, you can't. The thermostat decides the air quality status using the VOC levels that are defined by the system and not changeable from user side. However, you can change the air quality setpoint for each operating mode so that the thermostat can force air circulation once the VOC level is detected to be 10% higher than your customized setpoint.

For more information about air quality, see Air quality control [→ 24].

8.1.9 Where can I check the current time on the thermostat?

You can check the time under **Advanced Settings > Time**.

- If the thermostat has WLAN connection now and hasn't been powered off for more than three minutes, the time is displayed validly and correctly.
- If the thermostat has WLAN connection now but has been powered off for more than three minutes, the time may be displayed invalidly temporarily but will be synchronized with the server within 24 hours. Once the synchronization is done, the time will be displayed correctly again.
- If the thermostat doesn't have WLAN connection now, see more information in this section: Can the thermostat display the time correctly if there is no WLAN connection? [→ 36]

NOTE: To display the time correctly, it is important to set the time zone correctly. See Changing a time zone [→ 22] for more information.

8.1.10 Can the thermostat display the time correctly if there is no WLAN connection?

If there is no WLAN connection, the thermostat displays the time correctly only when:

- The thermostat connected to a WLAN network once and could display time correctly.
- The thermostat hasn't been powered off for more than three minutes.

Lacking either of the above conditions may result in incorrect time display.

8.1.11 Can I set the time manually?

No, you can't. The thermostat gets the time automatically after you've added the thermostat to a WLAN network and set a correct time zone.

8.1.12 Why is the time displayed incorrectly even though the thermostat is added to a WLAN network?

Maybe it is because the synchronization with the server hasn't started yet, or because the time zone is not selected correctly. Normally the server synchronizes the time at a fixed time of each day.

8.1.13 How does the built-in PIR sensor work?

See Presence detection using the built-in PIR sensor [→ 12].

8.1.14 What should I do if I forget my account's password?

Reset the password following the on-screen instructions in the app.

8.1.15 I have registered an account but cannot log in.

Check the email and ensure that you received an activation email. Follow the instructions to activate the account and then log in to the mobile app.

8.1.16 I have signed up but have not received a confirmation email.

Check for the email in the Spam or Deleted folder. If there is no email in these folders, request the confirmation email again.

8.1.17 Can I create more than one user account in the mobile app?

Yes, you can, but you cannot log into different accounts at the same time. Besides, it is normally unnecessary to do so if you want to manage more than one thermostat using the app, because one user account can associate with a maximum of 12 thermostats. However, one thermostat can only be associated with one user account. If your family members or colleagues want to manage the thermostats, you can share the account info with them.

See Account creation and pairing [→ 25] for more information about account creation.

8.1.18 How long are date and time valid, if power fails and the thermostat has no connection to the cloud?

If the power fails and thermostat powers up within five minutes, date and time are correct. Following power failure and thermostat restarts after five or more minutes, time is displayed only after synchronization is completed. The date is displayed as normal. The date and time will be synchronized automatically once power is resumed and internet is connected.

8.1.19 How long are settings saved in the thermostat if power fails?

User settings on the thermostat are not affected by power failure and remain until users change the original settings.

8.1.20 How does Free cooling work?

Before the thermostat starts **Free cooling**, change the following extended configuration:

- Set terminal input X1 or X2 to **Outside air temperature**.
- Set input **Aux Out W3/UNIV** to **Outside air damper**.
- Select **Advanced Settings > Optimization**, select **Yes** and set **Min.diff.room temp./outs.air temp.f.cool** for **Free cooling** to the desired value.

See system setup in [Commissioning](#) for more information on configuration changes.

When the temperature differential value (outside temperature minus room temperature) is higher than or equal to **Min.diff.room temp./outs.air temp.f.cool**, the thermostat starts cooling. When temperature differential value is below **Min.diff.room temp./outs.air temp.f.cool**, the thermostat stops cooling.

You can adjust **Min.diff.room temp./outs.air temp.f.cool** to influence **Free cooling**.

8.2 Technical specifications

Please refer to the [datasheet of this product](#) for technical specification details.

8.3 Regulatory information

8.3.1 ISED Regulations (Canada)

This device complies with Industry Canada license-exempt RSS standard(s).

Operation is subject to the following two conditions: (1) this device may not cause interference,

and (2) this device must accept any interference, including interference that may cause undesired operation of the device.

Le present appareil est conforme aux CNR d'Industrie Canada applicables aux appareils radio

exempts de licence. L'exploitation est autorisee aux deux conditions suivantes : (1) l'appareil ne

doit pas produire de brouillage, et (2) l'utilisateur de l'appareil doit accepter tout brouillage

radioelectrique subi, meme si le brouillage est susceptible d'en compromettre le fonctionnement.

8.3.2 FCC Regulations (USA)

	<p>⚠ WARNING</p> <p>Modification of this device to receive cellular radio telephone service signals is prohibited under FCC rules and federal law.</p> <p>This equipment has been tested and found to comply with the limits for a Class B digital device, pursuant to part 15 of the FCC Rules. These limits are designed to provide reasonable protection against harmful interference in a residential installation. This equipment generates, uses and can radiate radio frequency energy and, if not installed and used in accordance with the instructions, may cause harmful interference to radio communications. However, there is no guarantee that interference will not occur in a particular installation. If this equipment does cause harmful interference to radio or television reception, which can be determined by turning the equipment off and on, the user is encouraged to try to correct the interference by one or more of the following measures:</p> <ul style="list-style-type: none"> Reorient or relocate the receiving antenna. Increase the separation between the equipment and receiver. Connect the equipment into an outlet on a circuit different from that to which the receiver is connected. Consult the dealer or an experienced radio/TV technician for help. <p>This equipment complies with FCC radiation exposure limits set forth for an uncontrolled environment. This equipment should be installed and operated with minimum distance of 20cm between the radiator & your body.</p> <p>Changes or modifications not expressly approved by the party responsible for compliance could void the user's authority to operate the equipment.</p>
---	---

Statement

This device complies with part 15 of the FCC Rules. Operation is subject to the following two conditions: (1) This device may not cause harmful interference, and (2) this device must accept any interference received, including interference that may cause undesired operation.

8.4 EULA

The software included in this product is licensed for use subject to the Siemens end-user license agreement (EULA) posted at www.siemens.com/smart-thermostat or this software identified by product model or part number on the website. The open source software (OSS) information about the software can also be found from the same website.

Issued by
Siemens Industry, Inc.
Building Technologies Division
1000 Deerfield Pkwy
Buffalo Grove IL 60089
+1 847-215-1000

© Siemens Industry, Inc., 2017
Technical specifications and availability subject to change without notice.